

Data Sheet

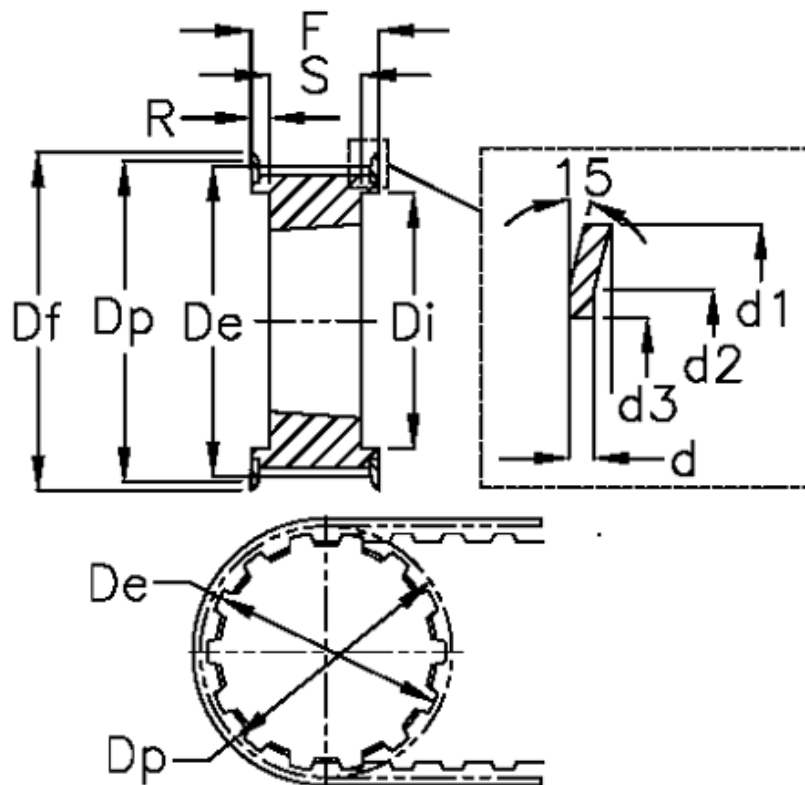

Article number: 604133038115
 Description: Taper bored timing belt pulley
 HTD 38 14M 115 TL 3020

Measures



d = 2.5	F = 133	Weight = 8.4
d1 = 184	Flange type = F55	Width = 115
d2 = 168	For bushing = 3020	
d3 = 135	Max bore = 75	
De = 166.6	r = 41	
Df = 184	S = 51	
Di = 130	Tooth number = 38	
Dp = 169.34	Type = 14M	